

PRINCIPAL PARTICULARS

LOH: 9.5m (HULL ONLY)
BEAM: 3.9m
DEPTH: 2.0m
DRAFT: 0.41m (HULL)
D/RISE: 12°
DISPL: 4300KG
ENG: 2x 150-300HP

9.5m POWER CAT
GENERAL ARRANGEMENT

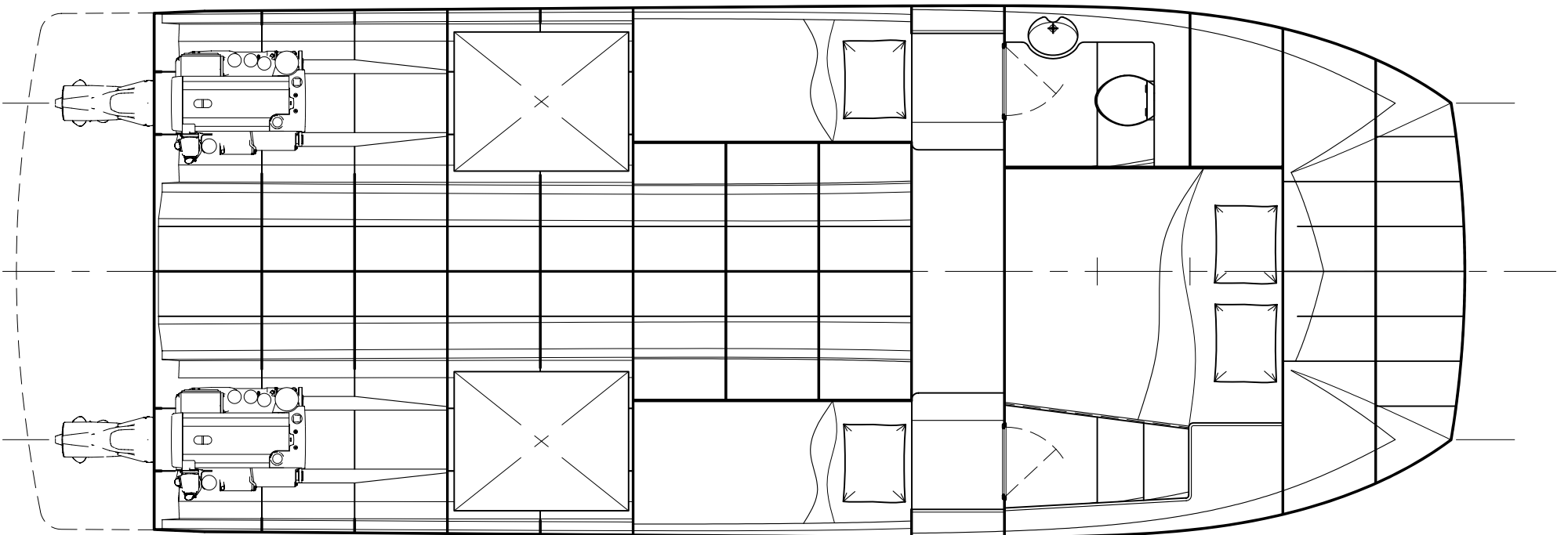
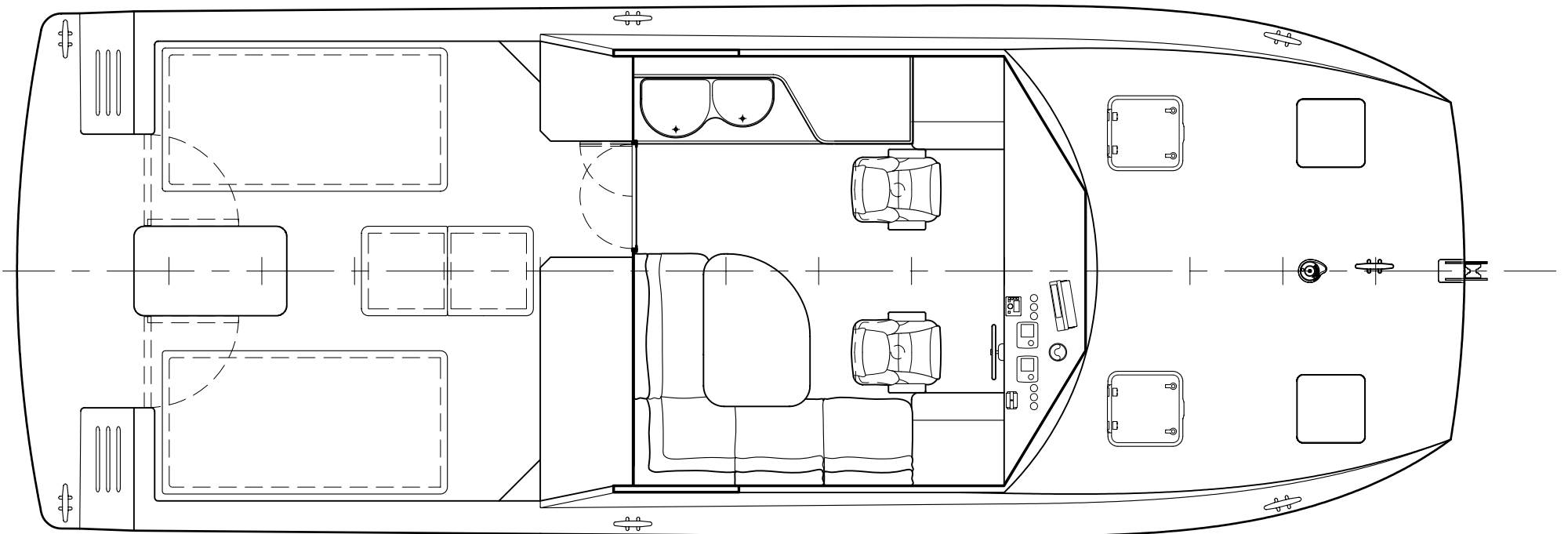
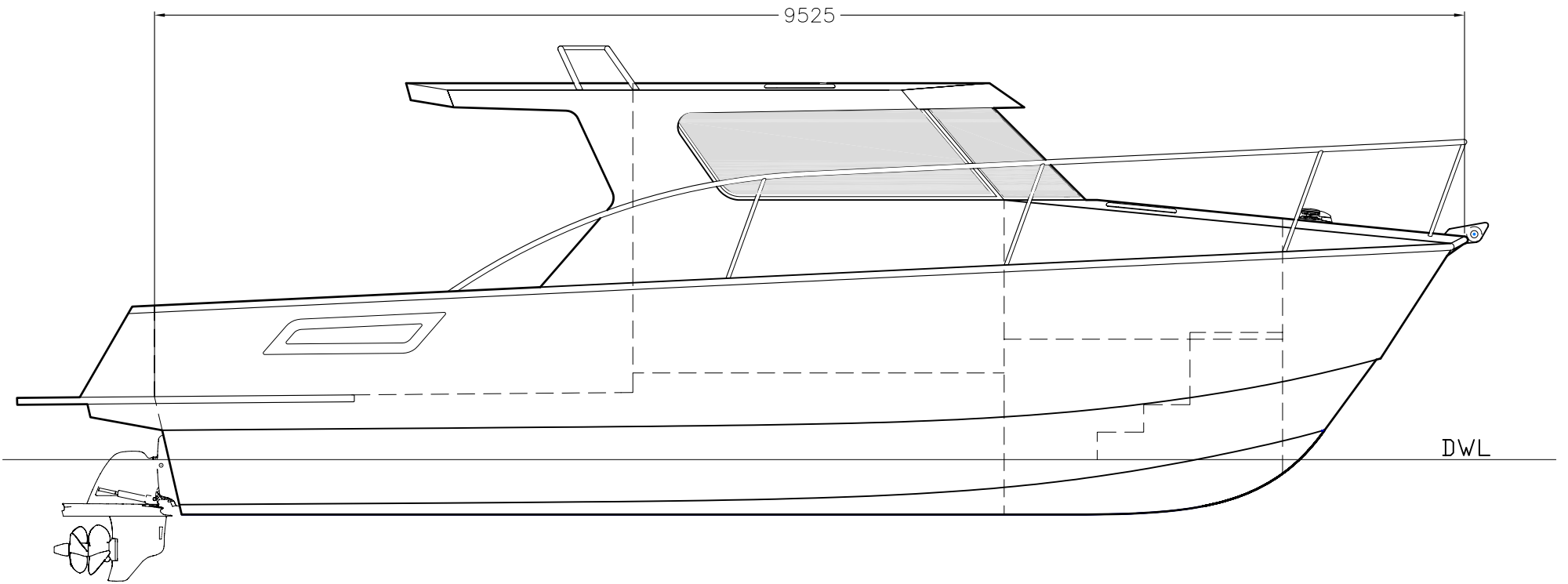

www.platealloy.com



Kit Notes: Launcher, Fuel Tanks, Bow rail and anchor gear not included in Flat Pack Kit

This drawing is the property of CTMD 31 Perrins Creek Road Olinda, Victoria, Australia - Phone: 0400 628 379 - www.ctmd.com.au

